

Data sheet | Item number: 253-108

2-conductor PCB terminal block; 1.5 mm²; Pin spacing 5 mm; 8-pole; PUSH WIRE®

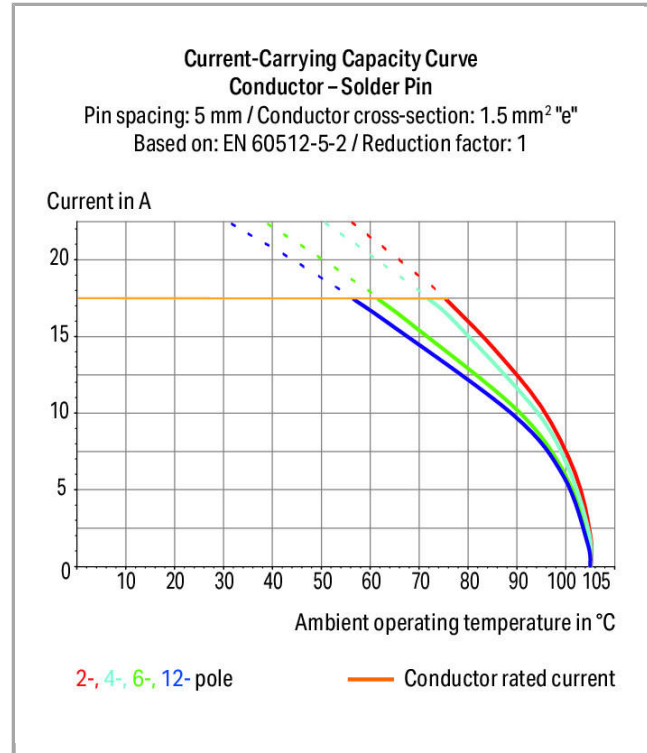

253-108

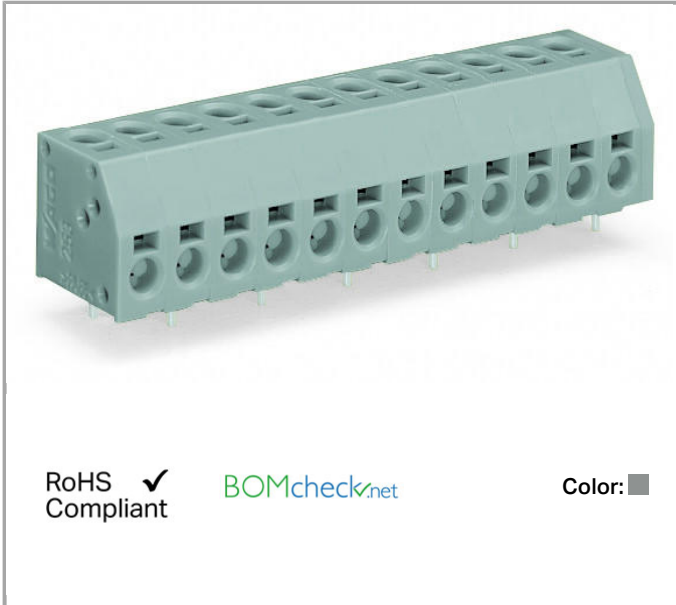

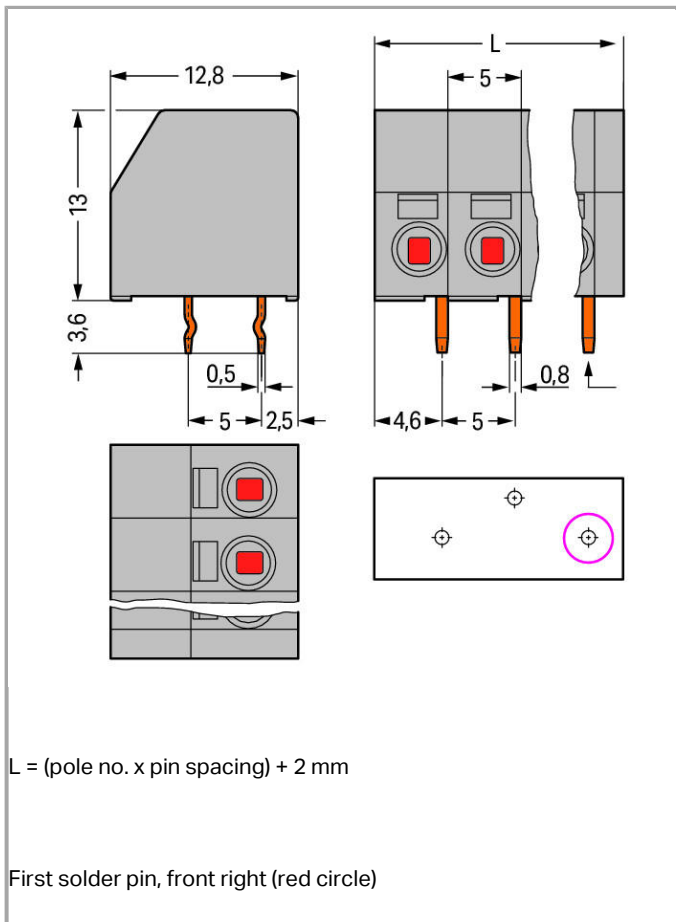

Item description

- PCB terminal strips with PUSH WIRE® connection and screwdriver actuation
- Double-conductor connection provides top-entry (vertical) and/or side-entry (horizontal) wiring
- Push-in termination of solid conductors
- Double entries for power supply and potential distribution

Data

Electrical data

Ratings per IEC/EN 60664-1

Rated voltage (III / 3)	320 V
Rated impulse voltage (III / 3)	4 kV
Rated voltage (III / 2)	320 V
Rated impulse voltage (III / 2)	4 kV
Rated voltage (II / 2)	630 V
Rated impulse voltage (II / 2)	4 kV
Rated current	17.5 A

Approvals per UL 1059

Rated voltage UL (Use Group B)	300 V
Rated current UL (Use Group B)	8 A
Rated voltage UL (Use Group D)	300 V
Rated current UL (Use Group D)	8 A

Approvals per CSA

Rated voltage CSA (Use Group B)	300 V
Rated current CSA (Use Group B)	8 A
Rated voltage CSA (Use Group D)	300 V
Rated current CSA (Use Group D)	8 A

Connection data

Connection type (1)	PUSH WIRE® connection
Connection technology	PUSH WIRE®
Number of connection points (connection type)	1
Actuation type	Operating tool
Solid conductor	0.5 ... 1.5 mm ² / 20 ... 16 AWG
Strip length	8.5 ... 9.5 mm / 0.33 ... 0.37 inch
Note (strip length)	7 ... 8 mm / 0.28 ... 0.31 in. (for wiring on both sides)
Conductor entry angle to the PCB	0°
Connection type (2)	PUSH WIRE® connection
Connection technology 2	PUSH WIRE®
Number of connection points	1
Solid conductor (2)	0.5 ... 1.5 mm ² / 20 ... 16 AWG
Strip length (2)	8.5 ... 9.5 mm / 0.33 ... 0.37 inch
Note (strip length) 2	7 ... 8 mm / 0.28 ... 0.31 in. (for wiring on both sides)
Conductor entry angle to the PCB 2	90°
No. of poles	8
Total number of connection points	16
Total number of potentials	8
Number of connection types	2
Number of levels	2

Geometrical Data

Pin spacing	5 mm / 0.197 inch
Width	42 mm / 1.654 inch
Height	16.6 mm / 0.654 inch

Height from the surface	13 mm / 0.512 inch
Depth	12.8 mm / 0.504 inch
Solder pin length	3.6 mm
Solder pin dimensions	0.5 x 0.8 mm
Drilled hole diameter (tolerance)	1.1 ^(-...+0.1) mm

PCB contact

PCB contact	THT
Solder pin arrangement	over the entire terminal strip, staggered
Number of solder pins per potential	1

Material Data

Color	gray
Material group	I
Insulating material	Polyamide 66 (PA 66)
Flammability class per UL94	V0
Clamping spring material	Chrome nickel spring steel (CrNi)
Contact material	Electrolytic copper (E _{Cu})
Contact plating	tin-plated
Fire load	0.146 MJ
Weight	7.054 g

Environmental Requirements

Limit temperature range	-60 ... +105 °C
-------------------------	-----------------

Commercial data

Product Group	4 (Printed Circuit)
Country of origin	CN
GTIN	4044918689496
Customs Tariff No.	85369010000









Approvals / Certificates

Country specific Approvals

Logo	Approval	Additional Approval Text	Certificate name
	CCA DEKRA Certification B.V.	EN 60998	NTR NL 6580
	CCA	EN 60998	2126302.02

DEKRA Certification B.V.



	CCA DEKRA Certification B.V.	EN 60947	NTR NL-7649
	CCA DEKRA Certification B.V.	EN 60947	NTR NL-7122
	ENEC DEKRA Certification B.V.	EN 60947	71-101931
	ENEC DEKRA Certification B.V.	EN 60947	2160584.27
	VDE VDE Prüf- und Zertifizierungsinstitut	EN 60998	40028668
UL-Approvals			
Logo	Approval	Additional Approval Text	Certificate name
	cURus Underwriters Laboratories Inc.	UL 1059	E45172 sec. 6
	cURus Underwriters Laboratories Inc.	UL 1059	E45172 sec. 6
	UL UL International Germany GmbH	UL 1977	E45171

Compatible products



tools



Item no.: 210-647

Operating tool with partially insulated shaft; Blade (2.5 x 0.4) mm; short

210-647

	Item no.: 210-648 Operating tool with partially insulated shaft; Blade (2.5 x 0.4) mm; short; angled	210-648
	Item no.: 210-719 Operating tool with partially insulated shaft; Type 1, blade (2.5 x 0.4) mm	210-719
Marking accessories		
	Item no.: 210-332/500-202 Marking strips; as a DIN A4 sheet; MARKED; 1-16 (160x); Height of marker strip: 3 mm; Strip length 182 mm; Horizontal marking; Self-adhesive	210-332 /500-202
	Item no.: 210-332/500-204 Marking strips; as a DIN A4 sheet; MARKED; 17-32 (160x); Height of marker strip: 3 mm; Strip length 182 mm; Horizontal marking; Self-adhesive	210-332 /500-204
	Item no.: 210-332/500-205 Marking strips; as a DIN A4 sheet; MARKED; 1-32 (80x); Height of marker strip: 3 mm; Strip length 182 mm; Horizontal marking; Self-adhesive	210-332 /500-205
	Item no.: 210-332/500-206 Marking strips; as a DIN A4 sheet; MARKED; 33-48 (160x); Height of marker strip: 3 mm; Strip length 182 mm; Horizontal marking; Self-adhesive	210-332 /500-206
	Item no.: 210-833 Marking strips; on reel; 6 mm wide; plain; Self-adhesive	210-833

Downloads

CAD/CAE - Smart Data

CAD data

3D Download 253-108	URL	Download
---------------------	-----	----------

PCB libraries

DesignSpark Library for WAGO PCB Terminal Blocks Compatible with DesignSpark PCB Version 4.x or higher	2.1 Oct 6, 2014	zip 22.5 MB	Download
EAGLE Library for WAGO PCB Terminal Blocks Compatible with EAGLE PCB Design Software Version 6.x or higher	2.1 Oct 6, 2014	zip 23.9 MB	Download
TARGET Library for WAGO PCB Terminal Blocks Compatible with TARGET PCB Design Software Version 17.x	1.1.0 Oct 6, 2014	zip 27.1 MB	Download

Subject to changes.